

DÖRR

SURVEILLANCE CAMERA

GB INSTRUCTION MANUAL

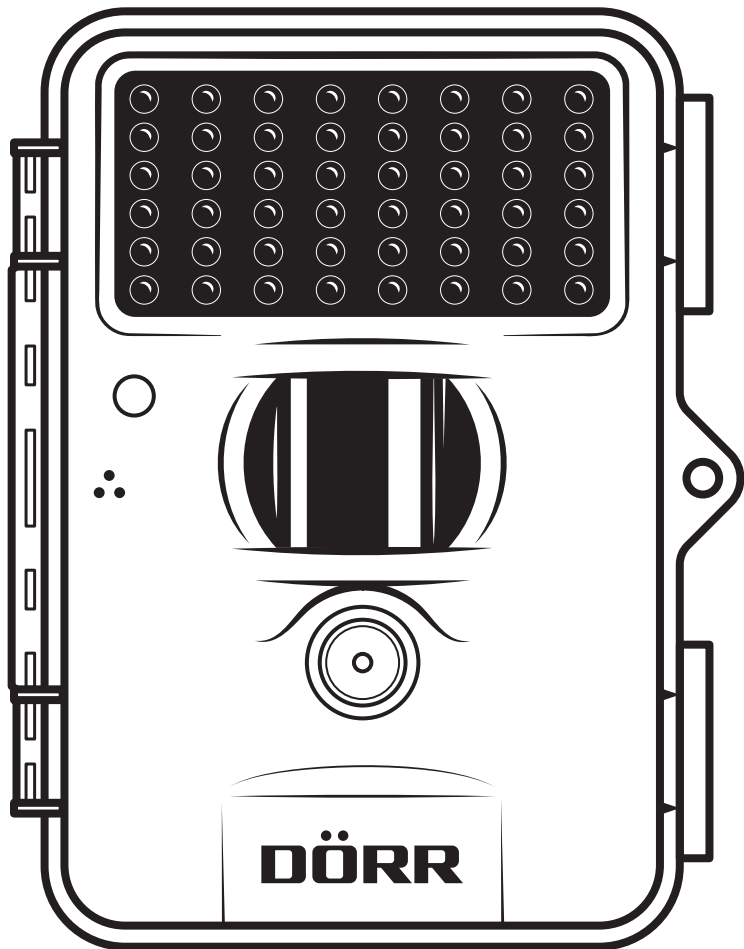

SNAPSHOT MINI BLACK 30MP 4K

INDEX		PAGE
01	SAFETY HINTS ⚠	3
02	SAFETY HINTS FOR BATTERIES ⚠	4
03	PRIVACY POLICY	4
04	NOMENCLATURE	4
05	ILLUSTRATION OF PARTS	5
06	FIRST COMMISSIONING	6
	06.1 Inserting the batteries	6
	06.2 Changing the batteries	6
	06.3 Alternative power supplies	6
	06.4 Inserting the SD/SDHC/SDXC Memory Card	6
07	OPERATION	7
	07.1 Overview home screen	7
	07.2 All basic factory settings	7
	07.3 Main Menus	7
	07.4 Menu navigation	7
08	SETTINGS & FUNCTIONS	8
	08.1 Main Menu CAM	8
	08.2 Main Menu PIR	9
	08.3 Main Menu SYS	10
09	TEST RECORDINGS	11
10	MOUNTING · DIRECTING · ACTIVATING	11
	10.1 Mounting and directing the camera	11
	10.2 Turn on camera and start surveillance	11
	10.3 Notes for mounting the camera	11
	10.3.1 PIR Sensor	11
	10.3.2 Light conditions	11
	10.3.3 Weather protection	11
11	OPTIONAL ACCESSORIES	12
	11.1 Optional mounting accessories	12
	11.2 Optional anti-theft devices	12
12	PLAY & DELETE FILES	12
	12.1 View photos	12
	12.2 Slideshow	12
	12.3 Play videos	12
	12.4 Delete files	12-13
13	CLEANING AND STORAGE	13
14	TECHNICAL SPECIFICATIONS	13
15	SCOPE OF DELIVERY	14
16	DISPOSAL, CE MARK	14
	16.1 Disposal of batteries/accumulators	14
	16.2 WEEE Information	14
	16.3 RoHS Conformity	14
	16.4 CE Mark	14



THANK YOU very much for choosing a quality product by DÖRR.

Please read the instruction manual and the safety hints carefully before using the device for the first time.

Keep the operating instructions together with the device for reference. If other people use this device, provide them with these instructions. If you sell the unit, this manual forms an integral part of the device and must be supplied with it.

DÖRR is not liable for damage caused by improper use or failure to observe the operating and safety instructions.

In the event of damage caused by improper handling or by external influence, the guarantee or warranty claim becomes void. Any manipulation, structural modification of the product or opening of the housing by the user or an unauthorised third party shall be considered improper handling.

01 | SAFETY HINTS

- Your camera is fitted with a **weatherproof housing according to protection class IP66** (dust and jet waterproof) so that the camera can be used outdoors. Nevertheless, protect the camera from extreme weather conditions and direct sunlight.
- Caution! Make sure to use only fresh **Mignon AA LR6 1.5V Alkaline Manganese batteries of the same type and brand. When inserting the batteries please respect the correct polarity (+/-)**. Please remove batteries when device is not in use for a longer period.
- Do not use rechargeable batteries. They may lead to malfunction.
- Only use **SD/SDHC/SDXC memory cards from 4GB up to max. 256GB**. Using a micro SD card in combination with an adapter may lead to malfunctions.
- Do not drop the camera onto a hard surface. Do not use the camera if it has been dropped. In this case a qualified electrician should inspect the camera before you use it again.
- Do not attempt to repair the device by yourself. **Risk of electrical shock!** When service or repair is required, contact qualified service personnel.
- Do not open the camera housing (except the housing lid and the battery compartment) – the warranty will become void. The housing may only be opened by qualified DÖRR GmbH staff.
- LED bulbs can only be replaced by qualified DÖRR GmbH staff.
- **This device is not a toy! To prevent accidents and suffocation keep the device, the accessories and the packing materials away from children and pets.**
- People with physical or cognitive disabilities should use the camera with supervision.
- People with cardiac pacemakers, defibrillators or any other electrical implants should maintain a minimum distance of 30 cm, as the device generates magnetic fields.
- Do not use the camera nearby devices that generate strong electromagnetic fields.
- Avoid touching the camera lens with your fingers.
- Protect the camera against extensive dirt. Never use aggressive cleansing agents or benzine to clean the camera. We recommend a soft, slightly damp microfiber cloth to clean the outer parts of the camera and the camera lens. **Make sure to remove batteries before cleaning.**
- Store the camera in a dust-free, dry and cool place when not in use.
- If the device is defective or without any further use, dispose of the device according to the Waste Electrical and Electronic Equipment Directive WEEE. For further information, please contact your local authorities.

02 | SAFETY HINTS FOR BATTERIES

Only use high-quality batteries of popular brands. **When inserting the batteries, please respect the correct polarity (+/-).** Do not insert batteries of different types and always replace all batteries at the same time. Do not combine used batteries with fresh batteries. Please remove batteries when device is not in use for a longer period. **Do not throw the batteries into fire, do not short-circuit and do not disassemble them! Never charge non-rechargeable batteries – risk of explosion!** Remove empty batteries immediately from the device to avoid the leaking of battery acid. Remove leaking batteries from the device immediately. Clean the contacts before inserting fresh batteries. **Risk of battery acid burn!** In case of contact with battery acid, rinse the affected area immediately with water and contact a doctor. Batteries can be dangerous to life if swallowed. **Keep batteries away from small children and pets.** Do not dispose of batteries in household waste (see also chapter „Disposal of Batteries/Accumulators“).

03 | PRIVACY POLICY

In every country, legal data protection rules apply. As these rules may vary per country, please contact the appropriate authorities to learn about the latest privacy policy in your country. In any case kindly note:

- **Do not observe public areas such as sidewalks, roads, parking lots etc.**
- **Never observe your staff.**
- **Respect the general right of privacy.**
- **Do not publish pictures showing individuals without having their permission. Do not publish pictures showing identifiable automobile license plates.**
- **Make aware of the observed areas with a sign and inform your neighbours and visitors if necessary.**

04 | NOMENCLATURE

- 01 Infrared LEDs
- 02 LED indicator/light sensor
- 03 Motion detector (PIR sensor)
- 04 Microphone
- 05 Camera lens
- 06 Tension lock
- 07 Eyelet for U-lock (lock optional)
- 08 LCD camera display
- 09 Slide control (OFF/SETUP/ON)
- 10 MENU button
- 11 Navigation buttons
- 12 OK button/Play button
- 13 Battery compartment
- 14 DC 6V-12V port for external battery
- 15 Mini USB port
- 16 SD card slot
- 17 ¼" thread mount
- 18 Eyelets for cable lock (lock optional)
- 19 Eyelets for mounting strap
- 20 Mounting strap

05 | ILLUSTRATION OF PARTS

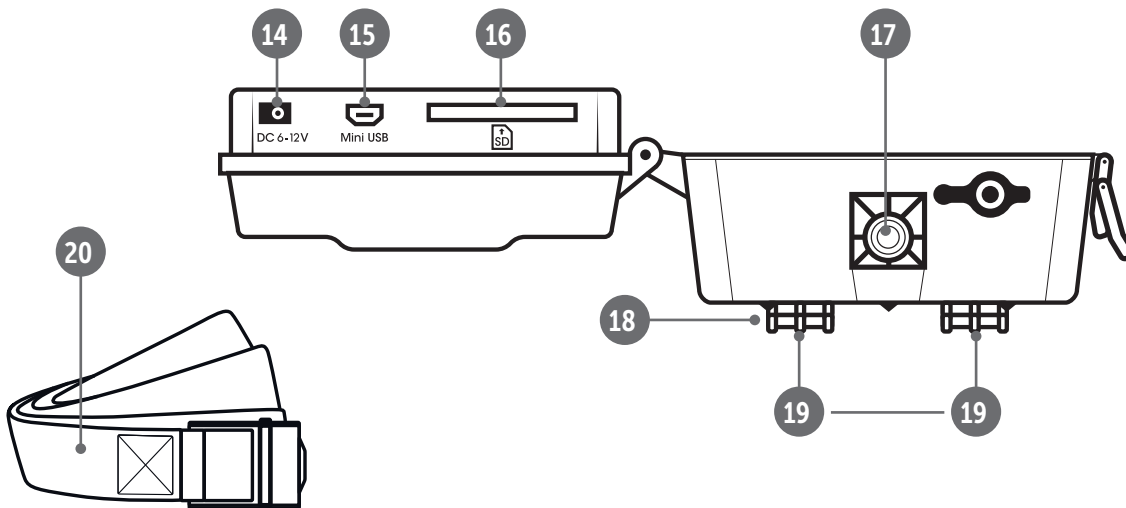
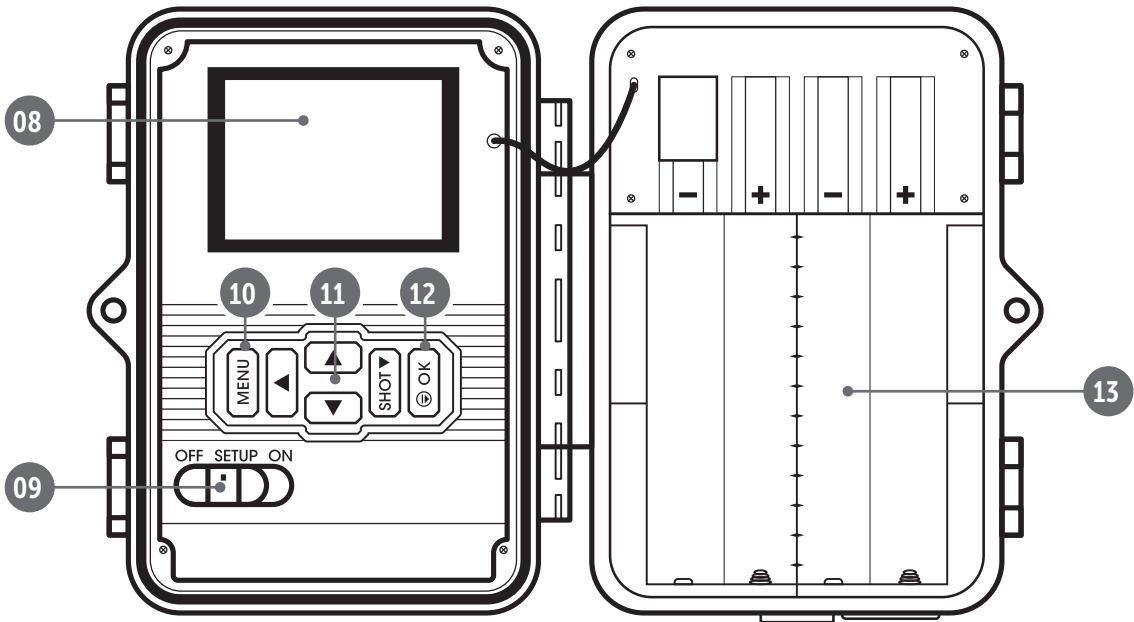
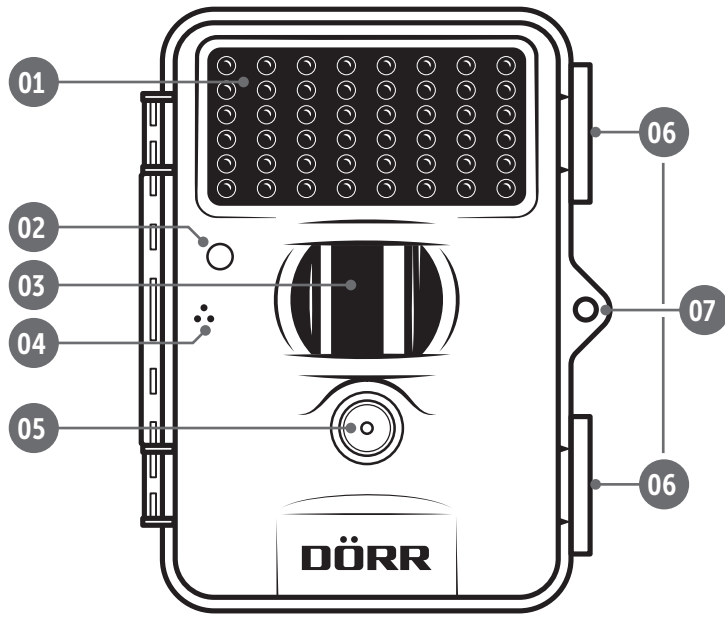

06 | COMMISSIONING

⚠ CAUTION

To avoid camera damages, make sure that camera is switched off (slide control 09 = OFF) for the following steps!

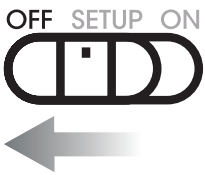

06.1 Inserting the batteries

⚠ CAUTION

Make sure to use only fresh Mignon AA LR6 1.5V Alkaline Manganese batteries of the same type and brand. When inserting the batteries please respect the correct polarity (+/-). Please remove batteries when device is not in use for a longer period. **Do not use rechargeable batteries. They may lead to malfunction.**

Open the camera releasing the lateral tension locks (06). Make sure that the slide control (09) is on position **OFF**. Insert **8 pcs AA 1,5V batteries** (not included) into the battery compartment (13). **Respect correct polarity (+/-).**

06.2 Changing the batteries

NOTE

Please note that the camera will keep the set time and date for about **1 minute** when replacing the batteries. If you need more time to change the batteries, the time and date must be set again (see **chapter 08.3**).

06.3 Alternative power supplies

Use the **DÖRR solar panel with internal Lithium Ion battery 1500 mAh** for a sustainable and extended runtime. Optionally available in our **DÖRR webshop**:

DÖRR Solar Panel Li-1500 12V/6V
www.doerr-outdoor.de/204446

Alternatively, the camera can be operated with an **external 6V or 12V battery** in conjunction with our **DÖRR battery cable**. All optionally available in our **DÖRR webshop**:

Lead Battery 12V/12Ah
www.doerr-outdoor.de/204347

Lead Battery 6V/4,5Ah

www.doerr-outdoor.de/204350

DÖRR Battery Cable 2m with flat plug

www.doerr-outdoor.de/204364

Both the solar panel and an external battery need to be plugged-in to the cameras DC 6V-12V port (14). Any inserted batteries do not need to be removed when using external power supplies. The camera automatically reverts to the inserted batteries as soon as the external power supply is disconnected.

06.4 Inserting the SD/SDHC/SDXC memory card

⚠ CAUTION

Only use SD/SDHC/SDXC memory cards from 4GB to max. 256GB. A microSD card in combination with an adapter may lead to malfunctions.

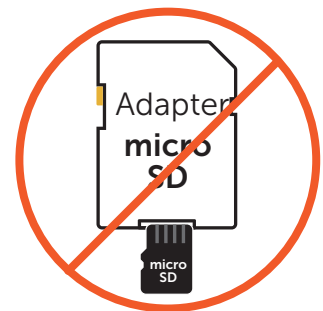

Make sure that the **SD card is formatted and unlocked**:



Insert the SD/SDHC/SDXC memory card (not included) with the **label facing upwards** into the SD card slot (16) until it snaps into place. How to format the SD card with the camera, please read **chapter 08.3**.

07 | OPERATION

07.1 Overview home screen

Switch the slide control (09) to the middle position **SETUP**.

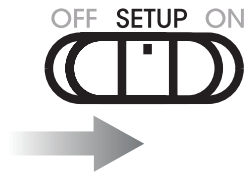

After the **DÖRR Logo** the LCD display (08) shows the **basic factory settings**:

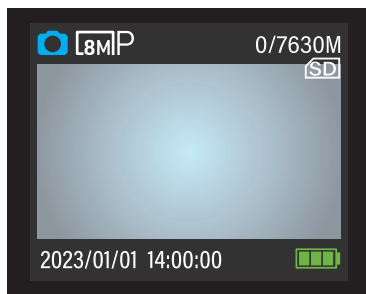

 **Camera is in single photo mode**

 **Resolution 8 Megapixel**

0/7630M **Number of pictures saved on SD card/
free capacity**

 **Correctly inserted memory card**

2023/01/01 14:00:00 **Date/time**

 **Battery level**

The default language of the camera menu is **GERMAN**. To change the menu language, please read **chapter 08.3**.

07.2 All basic factory settings

Camera mode:	Photo
Photo settings:	Resolution: 8MP
	Flash Power: Middle
	Photo Burst: 1 Photo
Trigger mode:	PIR Trigger
PIR Sensitivity:	Low
PIR Interval (Delay):	30 seconds
Work time 1 - 4:	Off
Password protection:	Off
Rename:	On
Overwrite:	On

07.3 Main Menus

To adjust the settings for your purposes, switch the slide control (09) to the middle position **SETUP** and press the menu button (10) . The 3 main menus appear in the top left of the LCD display (08). The selected main menu is shown with a **blue icon**:

Main menu CAM



Here you can adjust the **camera settings**. You can see the different settings in **chapter 08.1**.

Main menu PIR













Here you can adjust the **trigger settings**. You can see the different settings in **chapter 08.2**.

Main menu SYS



Here you can set the **language, date, password etc.** You can see the different settings in **chapter 08.3**.

07.4 Menu navigation

- Press the navigation buttons (11)  or  to select the desired main menu. The selected main menu is shown with a **blue icon**.
- Press the navigation buttons (11)  or  to select the submenu. The selected submenu is **highlighted in blue**.
- Press the OK button (12)  to enter and to adjust the submenu.
- Press the navigation buttons (11)  or  to select the desired setting.
- To save your settings press the OK button (12) .
- Press the menu button (10)  to return to the parent menu. Press the menu button (10)  again to return to the home screen.

08.1 Main menu CAM		 CAM	
Camera Mode	Photo ✓	Selection Photo . The camera takes pictures according to your further selection under Photo Settings .	
	Video		
	Photo & Video		
	Photo Settings →	<p>→ Photo Size</p> <p>Select the desired image resolution.</p>	<p>5MP (3072x1728 pixels)</p> <p>8MP (3840x2160 pixels)</p> <p>16MP (5376x3024 pixels)</p> <p>20MP (6144x3456 pixels)</p> <p>24MP (6528x3672 pixels)</p> <p>30MP (7296x4104 pixels)</p>
		<p>→ Photo Flash Power</p> <p>Select the desired flash range.</p>	<p>Low (approx. 6 meters)</p> <p>Middle (approx. 10 meters)</p> <p>High (approx. 15 meters)</p>
		<p>→ Photo Burst</p> <p>Select the number of images to be taken upon movement or triggering.</p>	<p>1 - 10 Photos</p>
Camera Mode	Photo	Selection Video . The camera makes videos according to your further selection under Video settings .	
	Video ✓		
	Photo & Video		
	Video Settings →	<p>→ Video Size</p> <p>Select the desired video format.</p>	<p>720P (HD 1280x720)</p> <p>1080P (Full HD 1920x1080)</p> <p>2.7K (2688x1520)</p> <p>4K (Ultra HD 3840x2160)</p> <p>WVGA (848x480)</p>
		<p>→ Video Length</p> <p>Select the desired video length.</p>	<p>5 sec - 1 min</p>
		<p>→ Video Flash Power</p> <p>Select the desired flash range.</p>	<p>Low (approx. 6 meters)</p> <p>High (approx. 12 meters)</p>
Camera Mode	Photo	Selection Photo & Video . The camera first takes a photo or photos and then records a video, according to your further selection under Customs settings .	
	Video		
	Photo & Video ✓		
Customs Settings →		→ Photo Size	→ 5MP, 8MP, 16MP, 20MP, 24MP, 30MP
		→ Photo Flash Power	→ Low, Middle, High
		→ Photo Burst	→ 1 - 3 Photos
		→ Video Size	→ 720P, 1080P, 2.7K, 4K, WVGA
		→ Video Length	→ 5 sec - 1 min
		→ Video Flash Power	→ Low, High

08.2 Main menu PIR



PIR

Trigger Mode	PIR Trigger ✓ Time Lapse Both	The Passive Infrared Sensor (PIR) triggers upon motion and temperature changes recognised within the detection range.																					
PIR Sensitivity	→	Low	Select when camera triggers too often upon environment influences, e.g. falling branches or strong sunlight.																				
		High	The camera recognises even smallest motion and temperature changes.																				
PIR Interval	→	0 sec - 60 min	Set a pause for the PIR Sensor. This setting prevents the camera from taking too many images/videos. Example with setting 5 minutes: After triggering, the camera sets the PIR inactive for 5 minutes. After the time set the PIR sensor will be active again.																				
Trigger Mode	PIR Trigger Time Lapse ✓ Both	The camera triggers according to the specific time set, independently from the PIR detector. Example with setting 01:00:00: The camera triggers every hour independently from motion recognition.																					
Time Lapse	→	1 min - 24 hours																					
Trigger Mode	Both ✓	With this setting, the PIR sensor triggers the camera not only according to your time lapse settings but additionally upon motion.																					
Work Times	Set a fixed working time frame in which the camera is active. Outside of this time, no recordings are made or movements are registered. Example with setting 2:00 p.m. – 5:00 p.m.: Camera is only active between 2:00 p.m. and 5:00 p.m. If you select the "Off" function in this menu item, the camera works 24 hours a day. You can set up to 4 working times per day.																						
Work Time 1	Off On ✓	→	<table border="1"> <thead> <tr> <th colspan="2">Start 00 00</th> <th colspan="2">Stop 00 00</th> </tr> </thead> <tbody> <tr> <td>All</td> <td><input checked="" type="checkbox"/></td> <td>Sun</td> <td><input checked="" type="checkbox"/></td> </tr> <tr> <td>Mon</td> <td><input checked="" type="checkbox"/></td> <td>Tue</td> <td><input checked="" type="checkbox"/></td> </tr> <tr> <td>Wed</td> <td><input checked="" type="checkbox"/></td> <td>Thu</td> <td><input checked="" type="checkbox"/></td> </tr> <tr> <td>Fri</td> <td><input checked="" type="checkbox"/></td> <td>Sat</td> <td><input checked="" type="checkbox"/></td> </tr> </tbody> </table>	Start 00 00		Stop 00 00		All	<input checked="" type="checkbox"/>	Sun	<input checked="" type="checkbox"/>	Mon	<input checked="" type="checkbox"/>	Tue	<input checked="" type="checkbox"/>	Wed	<input checked="" type="checkbox"/>	Thu	<input checked="" type="checkbox"/>	Fri	<input checked="" type="checkbox"/>	Sat	<input checked="" type="checkbox"/>
Start 00 00		Stop 00 00																					
All	<input checked="" type="checkbox"/>	Sun	<input checked="" type="checkbox"/>																				
Mon	<input checked="" type="checkbox"/>	Tue	<input checked="" type="checkbox"/>																				
Wed	<input checked="" type="checkbox"/>	Thu	<input checked="" type="checkbox"/>																				
Fri	<input checked="" type="checkbox"/>	Sat	<input checked="" type="checkbox"/>																				
Work Time 2	Off On ✓	→	<table border="1"> <thead> <tr> <th colspan="2">Start 00 00</th> <th colspan="2">Stop 00 00</th> </tr> </thead> <tbody> <tr> <td>All</td> <td><input checked="" type="checkbox"/></td> <td>Sun</td> <td><input checked="" type="checkbox"/></td> </tr> <tr> <td>Mon</td> <td><input checked="" type="checkbox"/></td> <td>Tue</td> <td><input checked="" type="checkbox"/></td> </tr> <tr> <td>Wed</td> <td><input checked="" type="checkbox"/></td> <td>Thu</td> <td><input checked="" type="checkbox"/></td> </tr> <tr> <td>Fri</td> <td><input checked="" type="checkbox"/></td> <td>Sat</td> <td><input checked="" type="checkbox"/></td> </tr> </tbody> </table>	Start 00 00		Stop 00 00		All	<input checked="" type="checkbox"/>	Sun	<input checked="" type="checkbox"/>	Mon	<input checked="" type="checkbox"/>	Tue	<input checked="" type="checkbox"/>	Wed	<input checked="" type="checkbox"/>	Thu	<input checked="" type="checkbox"/>	Fri	<input checked="" type="checkbox"/>	Sat	<input checked="" type="checkbox"/>
Start 00 00		Stop 00 00																					
All	<input checked="" type="checkbox"/>	Sun	<input checked="" type="checkbox"/>																				
Mon	<input checked="" type="checkbox"/>	Tue	<input checked="" type="checkbox"/>																				
Wed	<input checked="" type="checkbox"/>	Thu	<input checked="" type="checkbox"/>																				
Fri	<input checked="" type="checkbox"/>	Sat	<input checked="" type="checkbox"/>																				
Work Time 3	Off On ✓	→	<table border="1"> <thead> <tr> <th colspan="2">Start 00 00</th> <th colspan="2">Stop 00 00</th> </tr> </thead> <tbody> <tr> <td>All</td> <td><input checked="" type="checkbox"/></td> <td>Sun</td> <td><input checked="" type="checkbox"/></td> </tr> <tr> <td>Mon</td> <td><input checked="" type="checkbox"/></td> <td>Tue</td> <td><input checked="" type="checkbox"/></td> </tr> <tr> <td>Wed</td> <td><input checked="" type="checkbox"/></td> <td>Thu</td> <td><input checked="" type="checkbox"/></td> </tr> <tr> <td>Fri</td> <td><input checked="" type="checkbox"/></td> <td>Sat</td> <td><input checked="" type="checkbox"/></td> </tr> </tbody> </table>	Start 00 00		Stop 00 00		All	<input checked="" type="checkbox"/>	Sun	<input checked="" type="checkbox"/>	Mon	<input checked="" type="checkbox"/>	Tue	<input checked="" type="checkbox"/>	Wed	<input checked="" type="checkbox"/>	Thu	<input checked="" type="checkbox"/>	Fri	<input checked="" type="checkbox"/>	Sat	<input checked="" type="checkbox"/>
Start 00 00		Stop 00 00																					
All	<input checked="" type="checkbox"/>	Sun	<input checked="" type="checkbox"/>																				
Mon	<input checked="" type="checkbox"/>	Tue	<input checked="" type="checkbox"/>																				
Wed	<input checked="" type="checkbox"/>	Thu	<input checked="" type="checkbox"/>																				
Fri	<input checked="" type="checkbox"/>	Sat	<input checked="" type="checkbox"/>																				
Work Time 4	Off On ✓	→	<table border="1"> <thead> <tr> <th colspan="2">Start 00 00</th> <th colspan="2">Stop 00 00</th> </tr> </thead> <tbody> <tr> <td>All</td> <td><input checked="" type="checkbox"/></td> <td>Sun</td> <td><input checked="" type="checkbox"/></td> </tr> <tr> <td>Mon</td> <td><input checked="" type="checkbox"/></td> <td>Tue</td> <td><input checked="" type="checkbox"/></td> </tr> <tr> <td>Wed</td> <td><input checked="" type="checkbox"/></td> <td>Thu</td> <td><input checked="" type="checkbox"/></td> </tr> <tr> <td>Fri</td> <td><input checked="" type="checkbox"/></td> <td>Sat</td> <td><input checked="" type="checkbox"/></td> </tr> </tbody> </table>	Start 00 00		Stop 00 00		All	<input checked="" type="checkbox"/>	Sun	<input checked="" type="checkbox"/>	Mon	<input checked="" type="checkbox"/>	Tue	<input checked="" type="checkbox"/>	Wed	<input checked="" type="checkbox"/>	Thu	<input checked="" type="checkbox"/>	Fri	<input checked="" type="checkbox"/>	Sat	<input checked="" type="checkbox"/>
Start 00 00		Stop 00 00																					
All	<input checked="" type="checkbox"/>	Sun	<input checked="" type="checkbox"/>																				
Mon	<input checked="" type="checkbox"/>	Tue	<input checked="" type="checkbox"/>																				
Wed	<input checked="" type="checkbox"/>	Thu	<input checked="" type="checkbox"/>																				
Fri	<input checked="" type="checkbox"/>	Sat	<input checked="" type="checkbox"/>																				

Use the ▲ button to select the days you want the camera to be active.

Use the ▼ button to deselect the days when the camera should not be active.

Use the ► button to enter the next input field.



Set clock	Set the date and time .	Pre-set date format:	yyyy/mm/dd ✓	Year/Month/Day (Example 2023/01/15)
		Further date formats:	dd/mm/yyyy	Day/Month/Year (Example 15/01/2023)
			mm/dd/yyyy	Month/Day/Year (Example 01/15/2023)
		Time:	00 : 00	Time 24-Hours Format (Example 15:30)
Language	Select the desired language for the camera menu.	Pre-set menu language:	Deutsch ✓	
		Further menu languages:	English Dansk Suomi Svenska Français Italiano Čeština Norsk Magyar Español Nederlands	
Password	The camera can be password protected against unauthorized use. Default password: 0 0 0 0	Off ✓		No password input after switching on.
		On ✓	Set Password: 0 0 0 0	Enter a 4-digit code. NOTE We recommend writing down the password in a safe place, as the camera can no longer be operated if the password is lost. When the password function is activated, the password will be requested immediately after the camera is switched on.
Rename	The camera name will be shown on each image – recommended when using more than one camera.	Off ✓		No name on image.
		On ✓	Rename	Enter an 8-digit name consisting of numbers 0 - 9 and/or letters from A - Z .
Overwrite		Off ✓		If the SD card is full, the camera stops recording until the card is changed or formatted.
		On ✓		If the SD card is full, the camera overwrites the oldest files.
Format SD card		Yes ✓		This function deletes all files from the SD card and re-formats the memory card. NOTE Make sure that you do not need the files on the SD card anymore, before you start formatting!
		No ✓		You return to the submenu.
Default		Yes ✓		Restoring of Factory Settings. This function restores all settings to initial factory settings (except date and time).
		No ✓		You return to the submenu.
Software version				Shows current software version . No change of setting possible within this menu.

09 | TEST RECORDINGS

In **SETUP** mode (slide control 09 on position SETUP), a **test photo or test video** can be released and directly viewed.

Press the navigation button (11)  to take a **test photo**.

To view the test photo, press the OK button (12) .

To release a **test video**, press the navigation button (11)  to enter the video mode:



Press the navigation button (11)  to start the recording.

By pressing navigation button (11)  again the recording stops.

To view the video, press the OK button (12) .

10 | MOUNTING · DIRECTING · ACTIVATING

10.1 Mounting and directing the camera

Pull the **supplied mounting strap** (20) through the eyelet (19) on the backside of the camera. Mount the camera to a tree, pole or any other suitable object. Do not fix the belt finally at this stage.

We recommend placing the camera at a height of **0.75 m to 1.00 m**. The optimal distance to the subject is between **3 and 10 m**. Larger distances are possible as well, but then the reliability of the motion sensor is no longer given. The camera lens (05) should now point to where the object is expected to show-up.

To verify your camera is hung up in a correct angle, we recommend taking a view **test photos** (see **chapter 09**). The camera should be directed in a way that the object will appear in the centre of the picture. You may have to re-adjust the camera and take another test shot.

TIP To change the camera angle you can use e.g. a small wooden wedge between camera and trunk. Please also note **chapter 11** with our extensive range of **accessories for installation and anti-theft protection**.

Once the camera position is correct, the mounting belt (20) can be tightened to hold the camera firmly. After successful assembly and test recording, switch the camera off (09 = **OFF**).

10.2 Turn on camera and start surveillance

In order to get the camera ready to work, move the slide control (09) to the position **ON** and close the camera housing. **After approx. 5 seconds**, the camera will be active. In case of movements detected, it takes pictures according to your settings.

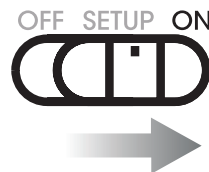

10.3 Notes for mounting the camera

10.3.1 PIR sensor

The PIR sensor triggers only under specific circumstances within a certain range. The capturing of objects strongly depends on temperature, vegetal cover, reflecting surfaces etc. Under perfect conditions the recognition range can be up to 20m. Usually, you may expect a range of 15 m. It may take a few attempts to find a good position for the camera. During photo test, be aware that animals are usually remarkably smaller than human beings. Animals might be below the PIR sensor detection range and not be captured.

10.3.2 Light conditions

Avoid direct backlight when mounting the camera. The lens should not point directly into the sun and camera should not be placed in shadow.

10.3.3 Weather protection

Although the camera is weatherproof and well-suited for outdoor use (dust and jet water protected according to IP66 protection class) we recommend mounting the camera in a secured place not facing the weather exposed side. Prevent the camera from driving rain and constant exposure to sunlight. After a long period of humidity caused by rain or fog, the camera should be placed in a dry area for a few days.

11 | OPTIONAL ACCESSORIES

11.1 Optional mounting accessories

Our optional accessories such as the **patented DÖRR holding fixture in combination with the DÖRR universal adapter** are designed for fast and easy mounting of the camera at a tree, wall or other objects. The camera clicks into the holding fixture and is firmly held in place. The camera can be removed easily for a quick change of place of action. The ball head ensure a flexible direction of the camera. The fixture is rotatable by 360° and swivels up to 30° in all directions:

DÖRR Holding Fixture Multi for SnapShot

www.doerr-outdoor.de/204490 

DÖRR UNI-1 Universal Adapter for Holding Fixture

www.doerr-outdoor.de/204495 

11.2 Optional anti-theft devices

Pull a **padlock** (available as accessory) through the eyelet (07) to lock the camera housing:

DÖRR Combination Lock 3-digits small

DÖRR Combination Lock 3-digits medium

www.doerr-outdoor.de/204454 

Use our **DÖRR cable lock** (available as accessory) and pull it through the eyelet for cable lock (18) on the backside of the camera to secure it against theft:

DÖRR Universal Cable Lock 1,80 m

www.doerr-outdoor.de/204452 

For a very high level of security, lock the camera in our **weatherproof and rust-free DÖRR metal housing „Made in Germany“**, which optimally protects your camera against theft, vandalism and extreme weather conditions:

DÖRR Metal Housing GH-M for SnapShot Mini

www.doerr-outdoor.de/204467 

Visit our web shop www.doerr-outdoor.de for a great variety of surveillance camera accessories and get more information on our wide assortment of **hunting and outdoor items!**

12 | PLAY & DELETE FILES

12.1 View photos

Slide the Switch (09) to position **SETUP**.



Press OK/playback button (12) . The camera display shows the latest recorded image. You can see whether the recording is a **photo or a video, the resolution with which the photo or video was taken and the number of recordings made** at the top left of the LCD display (08):

Photo:



Video:





Use navigation buttons (11)  or  to browse through your gallery.

12.2 Slideshow

Alternatively, you can play your recordings as a slide show:

Slide the Switch (09) to position **SETUP**.

Press the OK button (12) . Press the menu button (10) . Use the navigation button (11)  to select **Activate slide show**.

Press the OK button (12)  to start the slide show.

To end the slide show, press the navigation button (11) .



12.3 Play videos

If the recording is a video  1080P, press the navigation button (11)  to play the video on the LCD screen.



Press the OK button (12)  to return to the start screen.

12.4 Delete files

Slide the Switch (09) to position **SETUP**.

Press the OK button (12) . Use the navigation keys (11)  or  to select the file to be deleted.

Press the menu button (10) .

Use the navigation keys (11)  or  to select either:

Delete One in order to delete **just the selected file**, or **Delete All** if you want to delete **all pictures and videos** on your SD card.

Confirm your selection with the OK button (12) .

In the next step, confirm **Delete** or press **Cancel** to stop the deletion.

NOTE Once deleted, files can no longer be recovered!

13 | CLEANING AND STORAGE

Never use aggressive cleansing agents or benzine to clean the device. We recommend a soft, slightly damp microfiber cloth to clean the outer parts of the device. **Remove batteries before cleaning!** Store the device in a dust-free, dry and cool place. **This device is not a toy - keep it out of reach of children. Keep away from pets.**

14 | TECHNICAL SPECIFICATIONS

Recording capability	Photo / Video with audio / Photo + Video with audio
Combined picture and video recording	Yes
Number of LEDs / LED Type	48 invisible Black Vision Infrared LEDs, 940nm
Flash range max. approx.	15 m
Detection range motion sensor approx.	20m / 52°
Picture angle approx.	58°
Trigger speed PIR sensor approx.	0,2 s
Picture resolution	30MP, 24MP, 20MP, 16MP, 8MP, 5MP (interpolated)
Video resolution	Ultra HD 4K (3840x2160), 2,7K (2688x1520), Full HD (1920x1080), HD (1280x720), WVGA (848x480)
Video length	5-60 sec.
Digital picture format	JPEG
Digital video format	AVI
Mobile transmission	no
Display	2" LCD colour display
Playback on display	Photo + Video
Multiple shots (per release)	1-10 photos
Delay PIR Sensor	0 seconds to 60 minutes
Time frames per day	4
Time lapse function	Yes
Time stamp on image	Camera name, battery status, temperature (°F/°C), moon phase, date, time
Menu language	DE, GB, FR, ES, IT, NL, DK, FI, SE, NO, CZ, HU
Password protection	Yes
Memory card	SD/SDHC/SDXC 4GB to max. 256GB (not included). We recommend Class 10 or higher.
Protection class	IP66
Thread mount 1/4"	Yes
Compatible with Dörr Holding Fixture (Item-No. 204490)	Yes, with Uni 1 adapter (Item No. 204495, optional)
Power supply	8x Mignon AA LR6 1.5V Alkaline batteries (not included)
Operating voltage	6 V - 12 V
Socket for external battery	Yes
Operating temperature approx.	-20°C to +60°C
Storage temperature approx.	-30°C to +70°C
Relative humidity approx.	5% - 95%
Colour	olive green
Dimensions approx.	9,8 x 12,5 x 6,5 cm
Weight w/o batteries approx.	250 g

DÖRR GmbH reserves the right to make technical changes without notice.

15 | SCOPE OF DELIVERY

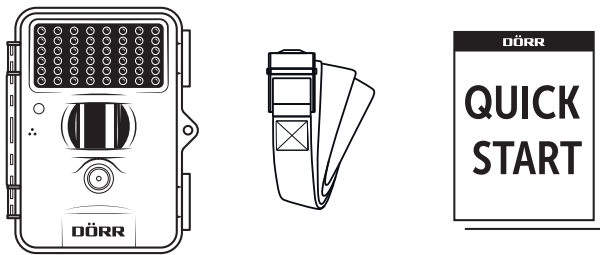

16 | DISPOSAL, CE MARKING

16.1 DISPOSAL OF BATTERY/ACCUMULATOR

Batteries and rechargeable batteries are marked with the symbol of a crossed-out waste bin. This symbol indicates that empty batteries or rechargeable batteries that can no longer be recharged must not be disposed of in household waste. Old batteries may contain harmful substances that can cause damage to health and the environment. As the end user, you are legally obliged to return used batteries (under German battery law, Section 11 Act Revising the Law of Waste-Related Product Responsibility for Batteries and Accumulators). You can return batteries free of charge after use at the point of sale or in your immediate vicinity (e.g. at municipal collection points or in shops). You can also return batteries to the seller by post.

16.2 WEEE INFORMATION

The WEEE (Waste Electrical and Electronic Equipment) Directive, which came into force as European law on 13 February 2003, led to comprehensive changes in the disposal of discarded electrical equipment. The primary purpose of this directive is to prevent e-waste while promoting reuse, recycling and other forms of reprocessing in order to reduce waste. The WEEE logo (dustbin) shown on the product and on the packaging indicates that the product must not be disposed of in normal household waste. You are responsible for delivering all discarded electrical and electronic equipment to appropriate collection points. Sorting waste for separate collection and sensible recycling of packaging waste helps to use natural resources more sparingly. Furthermore, e-waste recycling is a contribution to preserving our environment and thus also people's health. Further information on the disposal of electrical and electronic equipment, recycling and collection points can be obtained from local authorities, waste disposal companies, specialist retailers and the manufacturer of the device.

16.3 ✓ CONFORMITY WITH ROHS

This product complies with the European RoHS Directive on the restriction of the use of certain hazardous substances in electrical and electronic equipment and variations thereof.

62.4 CE MARK

The imprinted CE mark complies with the applicable EU standards and indicates that the device meets the requirements of all EU directives applicable to this product.

**DÖRR Surveillance Camera
SnapShot Mini Black 30MP 4K**

Item-No. **204500**

Made in China

DÖRR GmbH

Messerschmittstr. 1

D-89231 Neu-Ulm

Fon: +49 731 970 37 69

info@doerr.gmbh

<https://doerr-outdoor.de>